

Declarations & Terms

Products Update:

The listed products might be modified or discontinued without advising in advance.

Quotation:

Quotations are on Ex-Factory based Shenzhen China in currency of USD . CORITON may adjust the prices without prior notification. The proper discount might be available depending on the purchasing volume and items of the individual orders.

Payment:

Bank Transfer and Letter of Credit ,PayPal are recommended., customers will have to pay the bank fees at both sides.

Delivery time:

Approximately 1~4 weeks after confirm the order and payment. The exact delivery date should be finally confirmed by CORITON .

Return & Exchange:

Returning or exchanging are possible within 30 days after the goods are received, on the condition that quality problems are found and approved by CORITON . Problematic products could be repaired or exchanged when they are returned to CORITON factory, provided that failures are found within the warranty period. If no faults are found by CORITON or items are out of warranty, the customers should pay for the shipping cost .

Warranty :

CORITON Provide 24 months standard warranty for the reusable products list in this catalog after the goods are received.

Legal Affairs:

The original brands or trademarks indicated in the catalogue are for the purpose of referring to the compatibility with CORITON products. They are proprietarily owned by the respective manufacturers. Customers of CORITON are advised to be aware of the patent issues. CORITON products might be involved with in the marketed areas, and are responsible for the relevant legal affairs.



Better Medical Trolley Supplier

DISTRIBUTOR:



CORITON

CORITON Instrument Co., Ltd
5/F Building C, Gold Power Industry Park,
Pingshan Dist., Shenzhen, China 518118

Tel: +86 755 89581055 Fax: +86 755 89399952
Email: info@coriton.com www.coriton.com



A CE & ISO Certified Company
A Member of Chinamedi Group

CORITON

Good Health Support



ISO13485



ISO9001

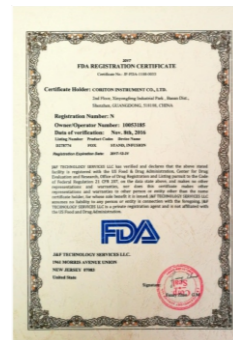

FDA List



National High Tech

Solutions

1-ECG Machine	01
2-Ultrasound	03
3-Ventilator	05
4-Endoscop	07
5-Infusion and Syringe pump	09
6-Computer/Laptop	11
7-Computer cart TR800/ TR700	13
8-Endoscopy cart TR900/ TR900C	21
9-Accessories for TR Series art	25

Profile

CORITON Instrument Co., Ltd was founded in 2009 with the goal of delivering high-quality, competitively priced medical mounting solution all over the world. CORITON specializes in the design, development, manufacturing, as well as sales and services of a wide range of mounting solutions for patient monitor, ECG machine, Ultrasound machine, and computer. Our company have get FDA, ISO9001 ,CE , RoHS certificate. CORIOTN products have already sold to more than 100 countries, include America, German, France. And setup partnerships with many medical device supplier all over the world.

China Factory :
CORITON INSTRUMENT CO., LTD.
Add: 5F Building C, Gold Power Industry Park,
Julongshan Grand industrial Zone, Pingshan Dist.,
Shenzhen, China 518118
Tel : +86 755 89581055 Email: info@coriton.com

Europe Warehouse and Sales office :
Umedwings Netherlands B.V.
Radonstraat 28, 2718TA Zoetermeer, The Netherlands
Tel: +31 (0) 642758955
Email: linda@coriton.com service@umedwings.com

American Warehouse and Sales office :
Orion Enterprises, Inc
Address: 111 Wheeling Road Wheeling IL 60090 USA
Tel: 847-562-1702
Email: usa@coriton.com

ECG Solutions



Model:TR700-300-02
ECG cart
Fixed height 1.0 m



Model:TR700-300-03
ECG cart
Fixed height 1.0 m



Model:TR700-300-04
ECG cart
Fixed height 1.0 m



Model:TR700-300-CN
ECG cart
Fixed height 1.0 m



Model:TR700-300-XX
ECG cart
Fixed height 1.0 m



Model:C.W.B.144-1
ECG cart



Model:C.W.B.144-07
ECG cable arm



Model:C.W.B.144-05
ECG cable arm



Model:C.W.B.144-06
ECG cable arm

Ultrasound Solutions



Model:TR700-XX
Ultrasound cart
Table 420*500mm



Model:TR700-XX
Ultrasound cart
Table 420*500mm



Model:RS004-1
Ultrasound cart
Table 390*520mm

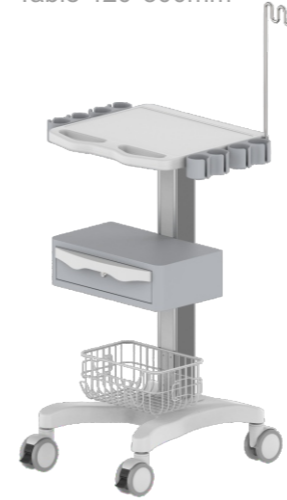

Model:RS010-100-4
+C.W.A.044
Ultrasound trolley
Table 420*400mm



Model:RS010-XX
Ultrasound trolley



Model:C.W.B.144-1
ECG cable arm



Model:RS010-100-3
+C.W.A.044
Ultrasound trolley
Table 420*400mm



Model:C.W.B.121
Probe cup holder

Ventilator Solutions



**Model:TR700-300-3
+AR102**
Ventilator trolley



**Model:TR800-300-XX
+AR102**
Ventilator trolley



Model:AR103
Ventilator Support Arm



Model:AR105
Ventilator Support Arm



Model:AR105
Ventilator Support Arm



Model:AR103
Ventilator Support Arm



Model:C.W.A.130-20
Humidifier slider

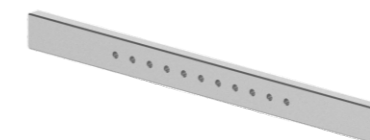

Model:C.W.B.130-04
Hanging wire metal strip

Endoscopy Solutions



Model:TR900-XX
Endoscope cart Height of 1.6m



Model:TR900-XX
Endoscope cart Height of 1.4m



Model:TR900C-12-03
Endoscope cart Height of 1.1m



NEW

Model:TR900-XX
Endoscope cart Height of 1.4m

Infusion/Syringe Pump solutions

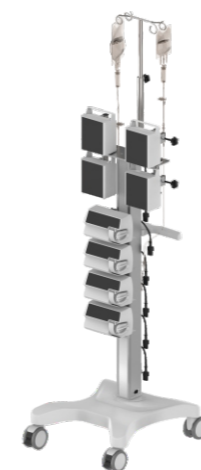

Model:TR800-300-XX
Infusion&injection pump cart
4+4 channels



Model:TR800-300-XX
Infusion&injection pump cart
4 channels



Model:TR800-300-XX
Infusion&injection pump cart
4+2 channels



Model:TR800-300-XX
Infusion workstation cart
6 channels

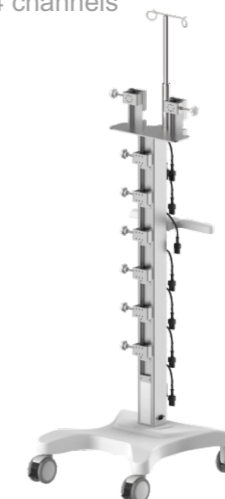

Model:TR800-300-XX
Infusion&injection pump cart
6+2 channels



Model:TR800-300-3
Infusion workstation cart



Model:TR800-300-XX
Infusion&injection pump cart
4+2 channels

NEW



Model:CL001-00
Functional clamps 30*30mm
Model:CL001-008-02
Functional clamps 25*25mm
Model:CL001-11-01
Functional clamps 19*19/20*20mm

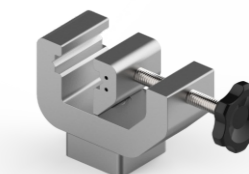

Model:CL001-15
Rotated clamp 40*15mm

Computer/Laptop Solutions



Model:TR700-300-02
Laptop cart
Desktop 420*500mm



Model:TR800-100-5-1
Laptop cart-Gas spring lift

Model:TR800-200-5-1
Laptop cart-Mechanical lift



Model:TR800-100-3-1
Computer cart-Gas spring lift

Model:TR800-200-3-1
Computer cart-Mechanical lift



Model:TR800-100-2+TR800.011
Computer cart-Gas spring lift

Model:TR800-200-2+TR800.011
Computer cart-Mechanical lift



Model:TR700-100-1
Computer cart-Gas spring lift



Model:TR700-200-1
+TR800.017
Computer cart-Mechanical lift

Computer Cart

TR800 Series



Model:TR800-100-3-1
Computer cart-Gas spring lift

Model:TR800-200-3-1
Computer cart-Mechanical lift



Model:TR800-100-5-1
Laptop cart-Gas spring lift

Model:TR800-200-5-1
Laptop cart-Mechanical lift



Model:TR800-100-2
Computer cart-Gas spring lift

Model:TR800-200-2
Computer cart-Mechanical lift



Model:TR800-100-2+TR800.011
Computer cart-Gas spring lift

Model:TR800-200-2+TR800.011
Computer cart-Mechanical lift



Model:TR800-300-6-2
Laptop cart
Fixed height 1.2m



Model:TR800-300-5-1
Laptop cart
Fixed height 1.2m



Model:TR800-300-6-3
Computer cart
Fixed height 1.2m



Model:TR800-100-XX
Remote teaching cart



Model:TR800-300-XX
medicine cart
Fixed height 1.4m



Model:TR800-300-2
Remote teaching cart
Fixed height 1.4m



Model:E.W.TG.TR800-200-NH
Cashier settlement cart
Fixed height 1.4m



Model:TR800-300-1-2
Round computer cart
Fixed height 1.4m

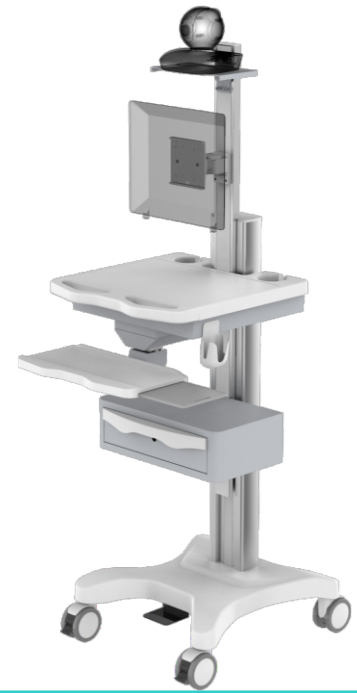

Model:TR800-300-6-3-XX
Computer cart



Model:TR800-300-5-1
4K Medical Screen Cart



Model:TR800-300-XX
Computer cart

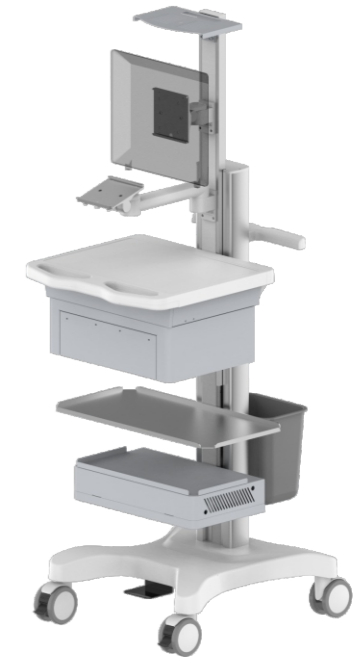

Model:TR800-200-XX
Mobile workstation

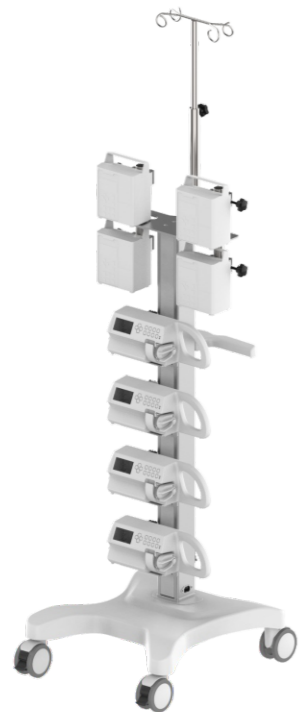

Model:TR800-300-XX
Infusion&injection pump cart
4+4 channels

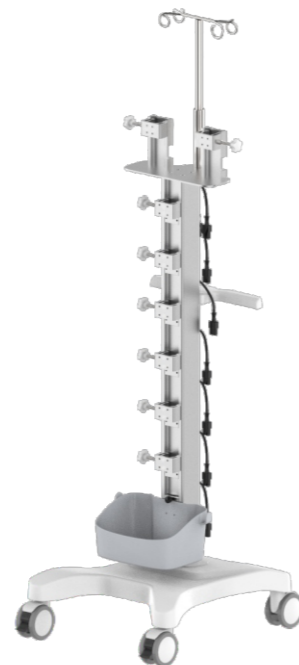

Model:TR800-100-XX
Infusion&injection pump cart
6+2 channels

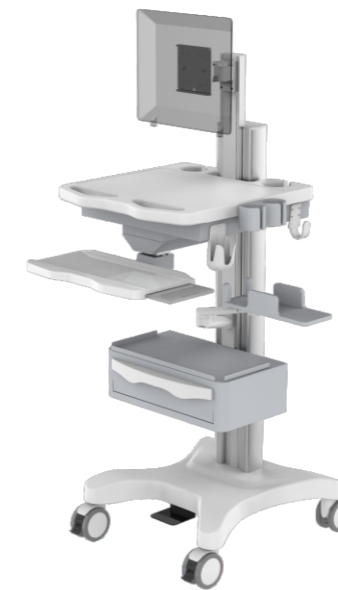

Model:TR800-200-XX
Mobile workstation



Model:TR800-300-XX
Computer cart

Computer Cart

TR700 Series



Model:TR700-100-1
Computer cart-Gas spring lift



Model:TR700-200-1
+TR800.017
Computer cart-Mechanical lift

HOT



Model:TR700-300-XX
IPAD cart
Fixed height 1m



Model:TR700-300-02
Laptop cart
Fixed height 1m



Model:R700-100-04
Laptop cart
Fixed height 1m



Model:TR700-300-CN
Laptop cart
Fixed height 1m



Model:TR700-200-XX
Computer cart-Mechanical lift



Model:TR700-200-XX
Remote teaching cart



Model:TR700-200-XX
Computer cart

Endoscopy Cart

TR900 Series



Model:TR900-XX
Endoscopy cart Height of 1.6m



Model:TR900-XX
Endoscopy cart Height of 1.4m



Model:TR900-XX
Endoscopy cart Height of 1.4m

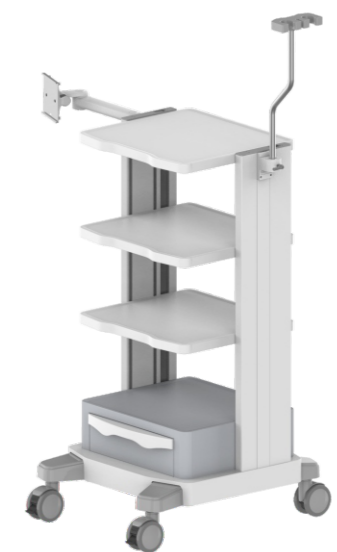

Model:TR900-XX
Endoscopy cart Height of 1.2m

Endoscopy Cart

TR900C Series



Model:TR900C-08-03
Endoscopy cart Height of 0.9m



Model:TR900C-08-04
Endoscopy cart Height of 0.9m



Model:TR900C-12-01
Endoscopy cart Height of 1.1m



Model:TR900C-12-03
Endoscopy cart Height of 1.1m

HOT



Model:TR800-300-08
TV cart-white
Model:TR800-300-0
TV cart-black
Fixed height 1.4m



Model:TR900C-12-XX
Endoscopy cart Height of 1.1m

Accessories for TR

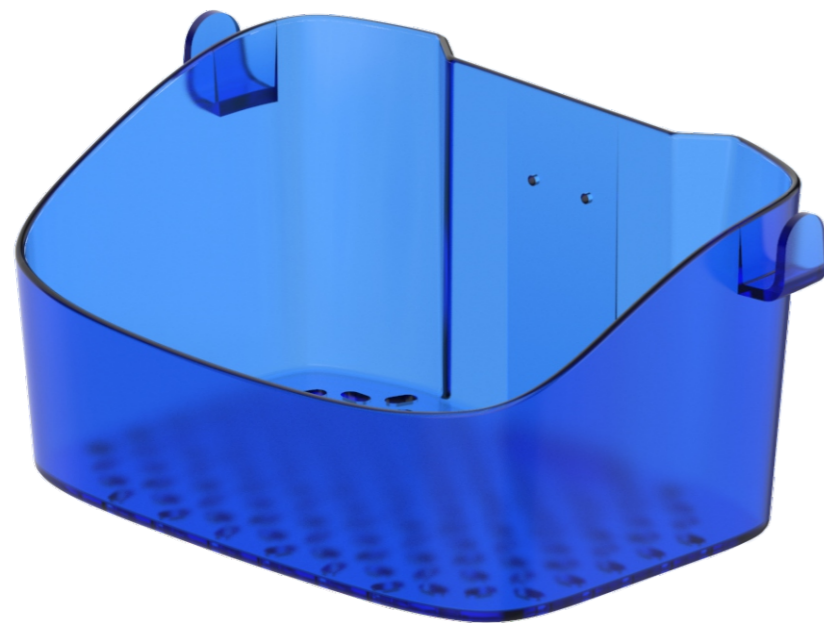

Model:C.W.B.139-02
Probe holder



Model:C.W.A.139-12
Probe holder

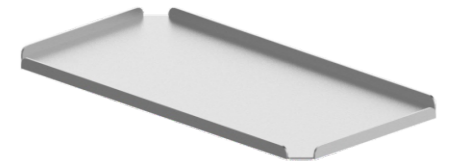

Model:TR800.017
Printer tray-410*263mm

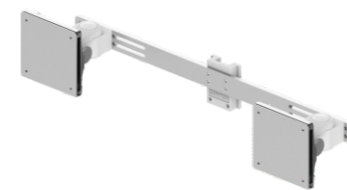

Model:TR800.011
Dual monitor arm-VESA

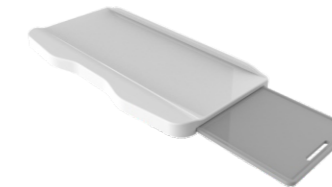

Model:TR800.006
Keyboard tray-ABS



Model:C.W.B.164-01
Keyboard tray-Aluminum alloy



Model:WM500-000-3
Monitor arm-VESA



Model:WM500-100-8
Monitor arm-VESA



Model:WM500-200
monitor arm-VESA



Model:TR800.029
Trash can
300*215*300mm

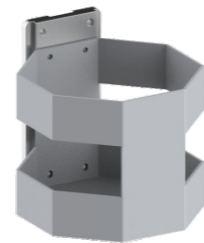

Model:C.W.B.164-02
Wipes box -diameter 12.5cm



Model:TR800.027
handle



Model:C.W.B.115-00
Computer host storage box(75~114mm)
Model:C.W.B.115-2
Computer host storage box(175-215mm)



Model:TR800.001
Standard Desktop
380*510mm



Model:TR800.003
Table
380*510mm



Model:TR800.002
Locked anti-theft desktop
380*510mm



Model:TR800.007
Locked anti-theft desktop
-Push-pull keyboard tray

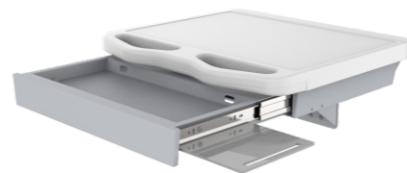

Model:TR700.002
Standard desktop
-hidden keyboard



Model:C.W.A.H.023-01
White plastic basket
340*213*149mm



Model:C.W.A.H.023
Gray plastic basket
340*213*149mm

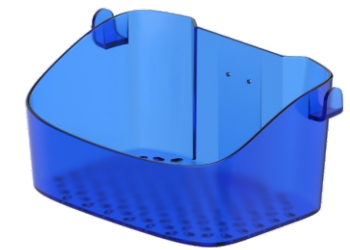

Model:C.W.A.H.023-02
Blue plastic basket
340*213*149mm



Model:C.H.A.019
Wire basket
335*215*143mm



Model:TR800.004-1
Double drawer with lock
450*260*350mm



Model:C.W.B.139-03
Single large drawer
450*510*150mm



Model:TR800.005-2
Single drawer with lock
450*260*140mm



Model:TR800.005-2
Single drawer with lock
510*470*150mm



Model:C.W.B.121
Probe cup holder



Model:C.W.B.144-07
ECG cable arm



Model:C.W.B.144-05
ECG cable arm



Model:C.W.B.144-06
ECG cable arm



Model:C.W.B.144-1
ECG cable holder



Model:C.W.B.021-11
Tablet anti-theft case

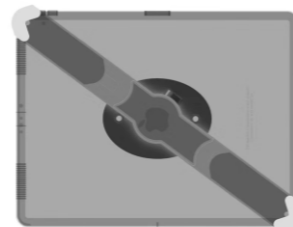

Model:C.W.B.021-08-02
IPAD shelf



Model:C.W.A.141-01-03
hanging hook



Model:C.W.A.130-20
Humidifier slider

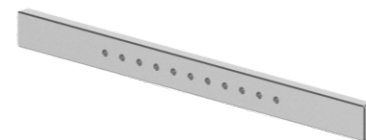

Model:C.W.B.130-04
Hanging wire metal strip

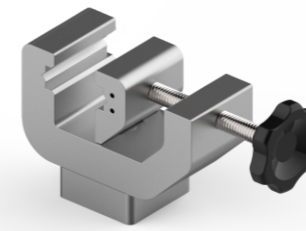

Model:CL001-15
Rotated clamp 40*15mm

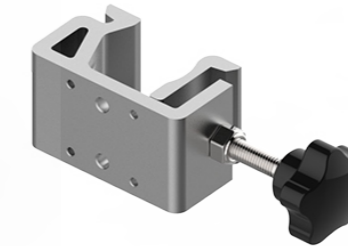

Model:CL001-00
Functional clamps 30*30mm
Model:CL001-008-02
Functional clamps 25*25mm
Model:CL001-11-01
Functional clamps 19*19/20*20mm